



INSTALLATION INSTRUCTIONS

IMPORTANT

Before assembling your access lighting fixture, please make sure that you carefully read through these instruction sheets. Consider having your fixture installed by a qualified licensed electrician.

NOTE: The important safeguards and instructions that appear in this manual are not meant to cover all possible conditions and situations that may occur. It must be understood that common sense, caution and care, are factors that can't be built into any product. These factors must be supplied by the person(s) caring for and operating the fixture.

GENERAL INFORMATION

All electrical connections must be in accordance with all ordinances, Local and National Electrical Codes. These fixtures are intended for mounting to a standard 4" x 2 1/2" metal octagon outlet box. The box must be directly supported by the building structure and U.L. Recognized.

STEP BY STEP INSTRUCTIONS

Before starting your installation disconnect the Power by turning off the Circuit Breaker or by removing the fuse at the fuse box. Just turning the light off at the light switch is not sufficient to prevent electrical shock.

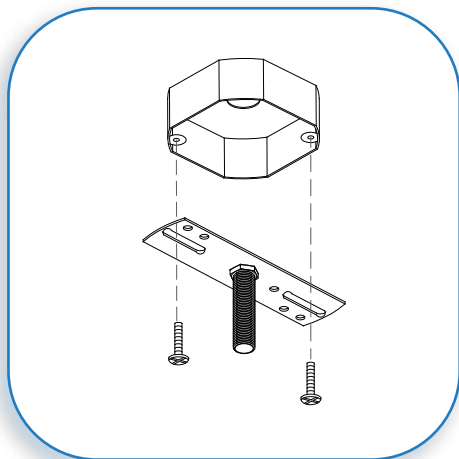

COLLECTION

APPLICATION

MODEL NO.

Pendant fixture

87120UJ

WHAT WE PROVIDE

- Mounting Hardware
- Fixture Assembly
- Transformer

WHAT YOU NEED

- Screwdriver
- Wire Cutters
- Wiring Supplies as Specified by Electrical Code

1

MOUNT CROSSBAR

If there is an existing fixture remove it. Mount the crossbar to the J-Box with the supplied mounting screws.

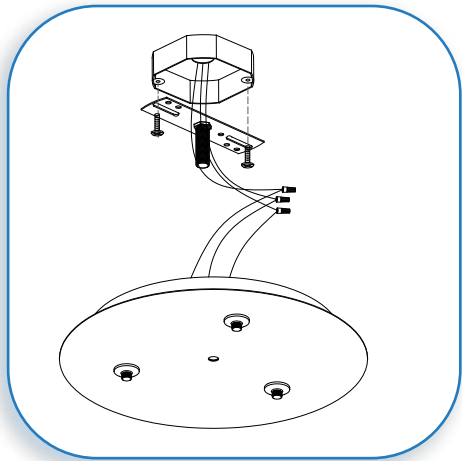

2

MAKE WIRE CONNECTION

Connect the black supply wire to the black transformer input wire. Secure with the supplied wire nuts.
 Connect the white supply wires to the white transformer input wire. Secure with the supplied wire nuts.
 Either wrap the green wire around one of the protruding screws or connect it to the supply ground
 Secure all wire with U.L certified electrical tape (not supplied). Tuck all wires carefully into the J-Box.

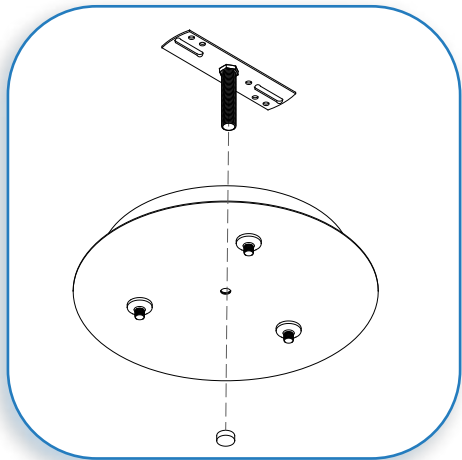

3

MOUNT CANOPY TO THE CROSSBAR

Place the Canopy over the Crossbar, secure with the Top cap.



4

**CONNECT THE UNI-JACK
 RESTORE THE ELECTRICITY AND
 CHECK THE OPERATION OF YOUR
 NEW ACCESS FIXTURE**

CAUTION Please ensure that the fitting is cool and switched off before replacing the bulb. DO NOT use bulbs that exceed the maximum wattage, stated on caution label.